

Interact Pro in school applications

This is all you need for your smart lighting system

interact
ready.



Philips Interact Ready products



Interact Pro app



Interact Pro web portal



Interact Pro gateway

Simple lighting control and automation

Recommended for
advanced features

Lighting is a simple but effective way to enrich students' learning experiences while contributing to a pleasant working environment for teachers and staff. Philips Interact Ready luminaires can help increase classroom comfort, adapt to different daytime activities, and help stimulate and engage pupils to achieve better learning results.

Install the Interact Pro smart lighting system to support:

Sustainability

- Save energy through demand-optimized lighting
- Avoid material waste with wireless and circular lighting

Student and staff health and well-being

- Create a customizable learning environment with scene setting
- Increase staff satisfaction with personalized control options
- Enhance a feeling of well-being of students and staff with personalized lighting recipes

Smart and safe learning environment

- Create safe, well-lit spaces for students and staff
- Support student performance with lighting for well-being
- Use scene scheduling to match the learning task and save energy at the same time

School lighting design insights

Glare

Use low-glare luminaires for comfort and to improve the experience of both students and teachers.

Controls

Locate sensors directly above desks to optimize presence detection. Lights respond instantly when sensors detect movement.

Brightness

Ensure the right level of light on student desks. EN12464-1 requires 500 lux for classrooms.

Board

Smartboards and projectors require less light than the rest of the classroom. To still have enough light throughout the room, install separate luminaires and controls.

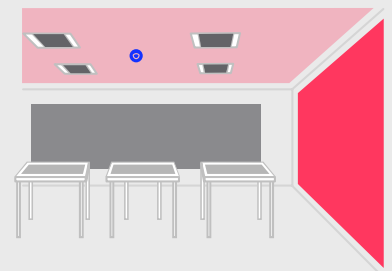

Sensor installation guidance

Easily enhance your smart lighting system with the Interact Ready external or luminaire-integrated wireless sensors. They trigger automatic responses to turn on, turn off or dim the lights according to occupancy detection and daylight variation. The result? Great energy savings and more control flexibility.

Motion detection area

With standalone wireless multisensor

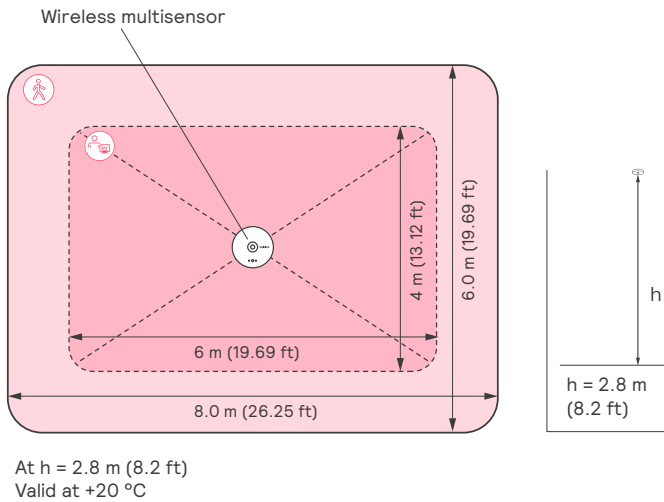

With multisensor integrated in luminaire

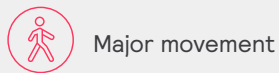
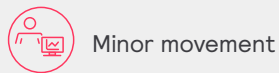
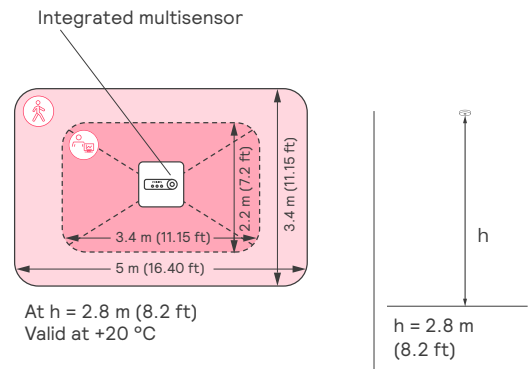

Typical classroom height: 2.8 m

Make sure you take the rectangular motion detection area into account when determining your sensor layout.

Daylight detection area

With standalone wireless multisensor

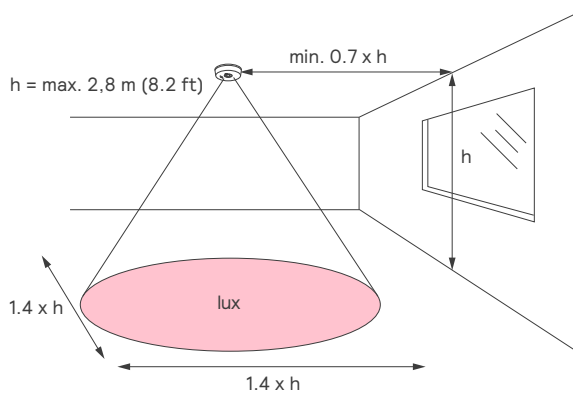

With multisensor integrated in luminaire

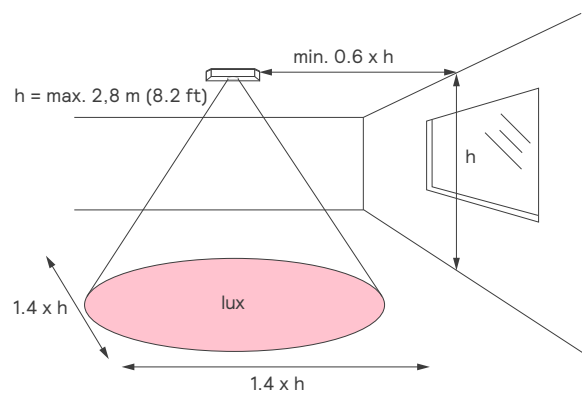

Installation guidance

Groups and zones

After installing and connecting all luminaires and controls to the Interact Pro app, you have the ability to group them together. A group consists of either zones or standalone lights. Zones enable you to control a set of luminaires as one entity, allowing them to dim or light up at the same time. You can assign luminaires to either groups or zones.

Each SNS-based luminaire has an integrated occupancy sensor that can trigger the group. Daylight regulation can be done on the basis of the individual luminaires. Additionally, each group can be activated by a maximum of 5 ZigBee Green Power sensors per group and 30 per network. Standalone lights and zones can be controlled individually to create scenes. Each zone can automatically adjust according to the amount of daylight, with sensors reacting to the light entering the classroom. Multisensors can also detect both movement and daylight.

Unlock more value with the Interact Pro gateway, including energy reporting, remote diagnostics, scene scheduling, off-site control, personal app control for lights and over-the-air upgrades.

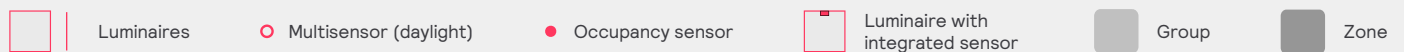
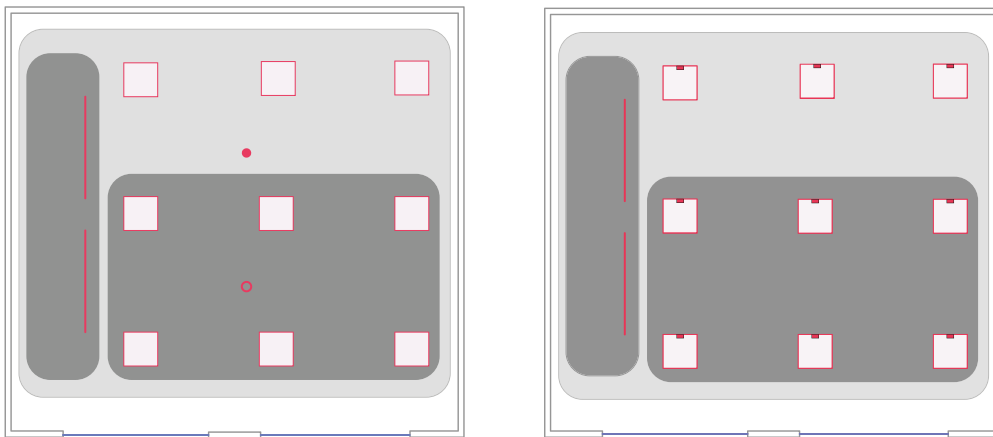

Installation guidance

Classroom floorplan with a typical luminaire arrangement.¹

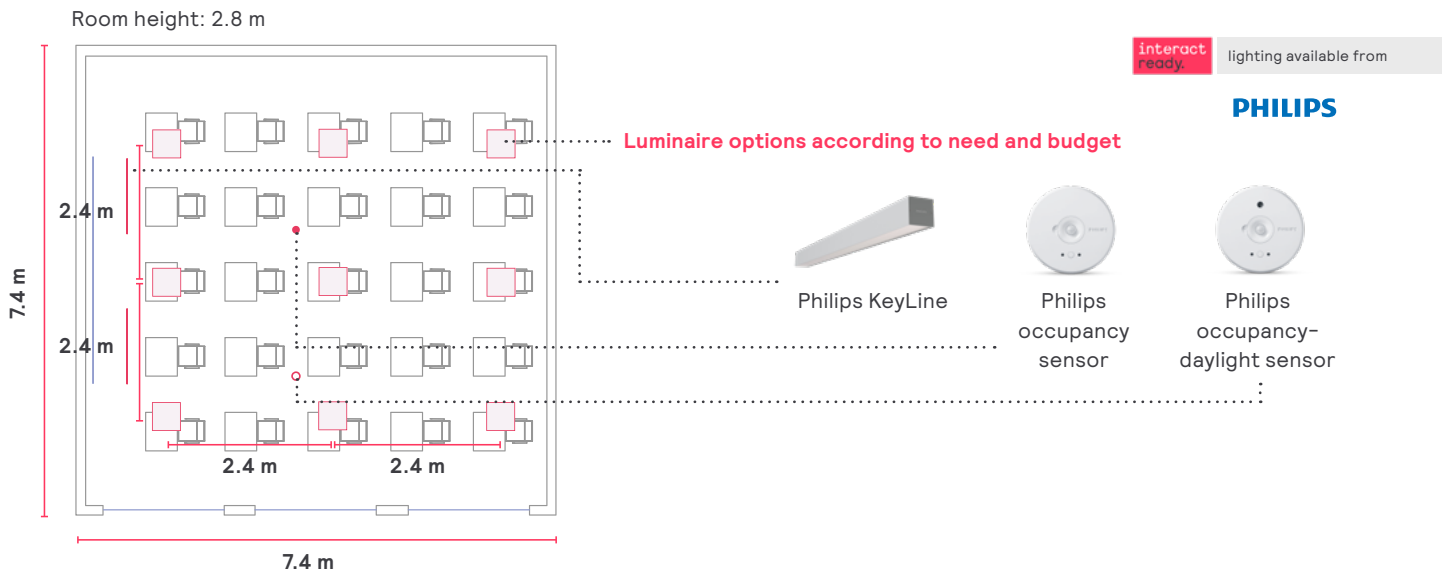

Option 1: Easy to install solution with good efficiency

Budget:

Product name	Quantity	Order code
Philips CoreLine panel RC132V G5 36S/840 WIA W60L60 OC	9	911401858084
Philips KeyLine SM350C 40S/840 WIA A PCS L1200 WH	2	available on request (via ETO)
Philips OCC 0100A/02 BP Sensor WH	1	913701067003
Philips OCC 0101A/02 DL BP Sensor WH	1	913701067103

Optional

Philips Switch Dim 4B (UID8480/10)	1	913701055803
------------------------------------	---	--------------



Option 2: High efficiency and ultra slim design

Budget:

Product name	Quantity	Order code
CoreLine recessed RC136B 43S/840 WIA W60L60 OC	9	911401896781
Philips KeyLine SM350C 40S/840 WIA A PCS L1200 WH	2	available on request (via ETO)
Philips OCC 0100A/02 BP Sensor WH	1	913701067003
Philips OCC 0101A/02 DL BP Sensor WH	1	913701067103

Optional

Philips Switch Dim 4B (UID8480/10)	2	913701055803
------------------------------------	---	--------------



Option 3: Ultimate flexibility with a minimalistic look

Budget:

Product name	Quantity	Order code
Philips KeyLine SM350C 40S/840 WIA PCS L1200 WH	9	910925868366
Philips KeyLine SM350C 40S/840 WIA A PCS L1200 WH	2	available on request (via ETO)
Philips OCC 0100A/02 BP Sensor WH	1	913701067003
Philips OCC 0101A/02 DL BP Sensor WH	1	913701067103

Optional

Philips Switch Dim 4B (UID8480/10)	2	913701055803
------------------------------------	---	--------------



¹This meets the minimum norm requirements for classroom lighting

Installation guidance

Classroom floorplan with a typical luminaire arrangement (sensor integrated in luminaire)¹

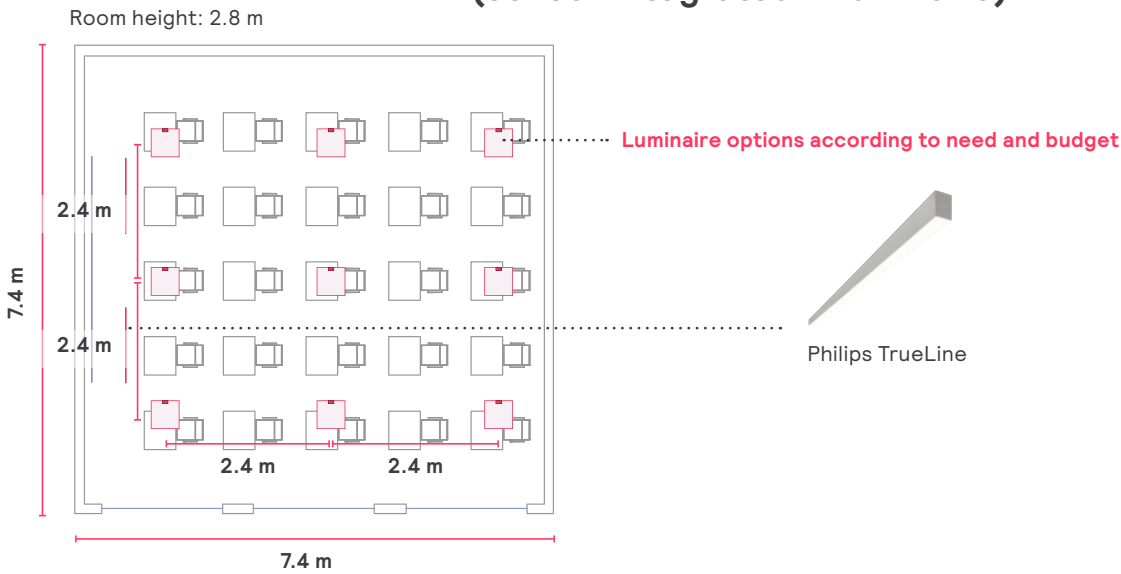

Interact ready. lighting available from

PHILIPS

Option 1: Easy to install solution with good efficiency

Budget: € ○ ○ ○ ○



Product name	Quantity	Order code
Philips CoreLine panel RC132V G5 43S/840 SIA W60L60 OC IA4	9	910505102377
Philips TrueLine SP530P LED40S/940 SRD A U4 L1170ALU	2	available on request (via ETO)

Optional

Philips Switch Dim 4B (UID8480/10)	2	913701055803
------------------------------------	---	--------------

Option 2: High-quality, sustainable choice²

Budget: € € ○ ○ ○



Product name	Quantity	Order code
Philips SlimBlend panel RC330V 42S/940 SIA W60L60 IA5 OC	9	910505102432
Philips TrueLine SP530P LED40S/940 SRD A U4 L1170ALU	2	available on request (via ETO)

Optional

Philips Switch Dim 4B (UID8480/10)	2	913701055803
------------------------------------	---	--------------

Option 3: Ultimate flexibility and super high efficiency

Budget: € € € ○ ○



Product name	Quantity	Order code
Philips TrueLine SP530P LED40S/940 SRD U4 L1170ALU	9	910505103237
Philips TrueLine SP530P LED40S/940 SRD A U4 L1170ALU	2	available on request (via ETO)

Optional

Philips Switch Dim 4B (UID8480/10)	2	913701055803
------------------------------------	---	--------------

Option 4: Tunable white-enabled lighting for well-being

Budget: € € € € ○



Product name	Quantity	Order code
Philips PowerBalance Tunable White RC461B LED80S/TW9 SIA W60L60 VPC U4 PIP	9	910505103383
Philips TrueLine SP530P LED40S/940 SRD A U4 L1170ALU	2	available on request (via ETO)

Optional

Philips Switch Dim 4B (UID8480/10)	2	913701055803
------------------------------------	---	--------------



Tunable white

Tunable white luminaires can easily change LED intensities and correlated color temperature (CCT) to mimic natural daylight patterns for optimal visual comfort.

Interact Pro allows you to set the default color temperature of luminaires and create scenes with a specific color temperature at group level. Luminaires automatically output the defined light level and color temperature when switched on.

¹This meets the minimum norm requirements for classroom lighting

































²Thanks to the recyclability and reparability of the product

School product overview

Below is a selection of Philips Interact Ready products that are suitable for a school environment. All lighting complies with the new European norm EN12464-2021 in the given luminaire arrangement.

Interact ready. lighting available from

PHILIPS

Recessed				Surface-mounted and suspended		
						
PowerBalance	SlimBlend	TrueLine	FlexBlend	CoreLine recessed	TrueLine	SlimBlend
Panel						
						
FlexBlend	KeyLine	CoreLine surface-mounted	MyCreation Accent cylinder	MyCreation Grand	CoreLine panel	CoreLine panel
Wall-mounted		Downlight				
						
CoreLine wall-mounted	LuxSpace	GreenSpace	MyCreation GreenSpace PerfectFit	MyCreation GreenSpace PerfectFit	MyCreation Drum	CoreLine downlight
Recessed spot				Wireless external battery sensor		Mains powered external sensors
						Coming soon
CoreLine slim downlight	LuxSpace Accent	GreenSpace Accent	CoreLine recessed spot	OCC0100A/02 BP Sensor WH	OCC0101A/02 DL BP Sensor WH	
Wireless switch		Gateway	Other		<p>* Luminaires with integrated sensor</p> <p>3D = 3D printed luminaires</p> <p>For a complete product overview go to: Philips.com/interact-ready</p>	
						
Switch Dim 2B (UID8470/10)	Switch Dim 4B (UID8480/10)	Interact Pro wireless gateway	Interact Ready RF DALI Connector	DALI Extender		

Tip: How to read our product type designations

You might stumble across the following abbreviations in the product names in the order lists of Philips Interact Ready products. Thanks to our legend, you can always order the right product with confidence.

U4 = Office sensor, with upgradable sensor slot

H4 = Highbay sensor

WIA = Wireless driver, Interact Ready

IA4 = Office sensor



© 2023 Signify Holding. All rights reserved. The information provided herein is subject to change, without notice. Signify does not give any representation or warranty as to the accuracy or completeness of the information included herein and shall not be liable for any action in reliance thereon. The information presented in this document is not intended as any commercial offer and does not form part of any quotation or contract, unless otherwise agreed by Signify.

All trademarks are owned by Signify Holding or their respective owners.

interact
by **signify**